

INFORMATION FOR PATIENTS

VIBRANT SYSTEM For Oral Use

Rx ONLY

Please talk to your healthcare provider if you have any questions or do not understand any of this information.



Table of Contents

What is the Vibrant System and Who should Use it?	3
Who should not Use the Vibrant System?	4
Important Safety Information	5
Warnings	5
Precautions	6
What are the Expected Benefits and Risks of Using the Vibrant System?	6
How to Use the Vibrant System	6
Setting Up the Pod	6
Activating and Taking the Capsule	7
Storage and Maintenance Instructions	9
Symbols	9

What is the Vibrant System and Who should use it?

The Vibrant System is an orally administered Capsule that is indicated for the treatment of adults with chronic idiopathic constipation (see description below) who have not experienced relief of their bowel symptoms by using laxative therapies at the recommended dosage for at least one month.

Chronic idiopathic constipation is a type of constipation associated with:

- Straining,
- Lumpy or hard stools,
- Incomplete evacuation (feeling that all the stool did not come out),
- Feeling like the stool is blocked from leaving the body while trying to use the bathroom
- 3 or fewer bowel movements per week and requiring manual manipulation (using hands to assist) for defecation in more than 25% of bowel movements.

The Vibrant System includes a reusable Pod, USB cable and AC/DC USB adapter, and single-use Capsules. The Pod is used to activate and calibrate the Vibrant Capsule before swallowing the Capsule. The Vibrant Capsule has small dimensions and a smooth shell to make it easy to swallow. The Capsule is expelled from the body during your regular bowel movements.

1. Pod
2. USB cable
3. AC/DC USB adapter
4. 2 blister packs of 10 Vibrant Capsules each, in 1 box

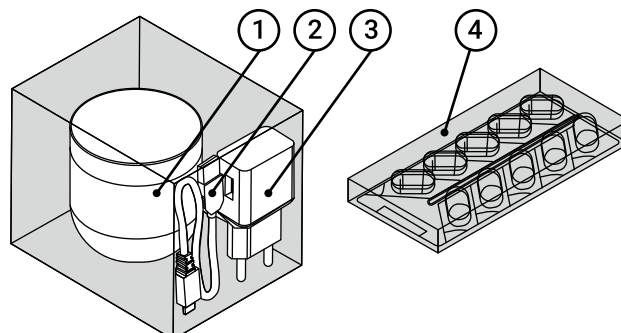

The Pod

The pod is used to activate the Vibrant Capsule before swallowing the Capsule.

1. Designated Groove for Capsule
2. Light ring indicator
3. Pod lid

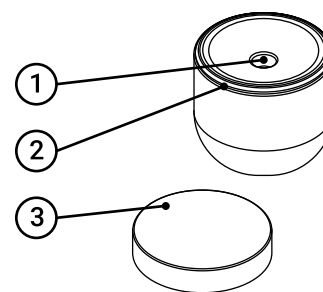

The Capsule should not cause any interference during travel activities such as flying and going through airport security.

Who should not Use the Vibrant System?

You should **not** use the Vibrant System if you:

- Have a history of complicated/obstructive diverticular disease (small sacs in the colon)
- Have a history of, or have suspected, obstruction in your small intestine or colon
- Currently have significant gastroparesis (stomach is unable to empty itself)
- Have a history of significant gastrointestinal disorder, including any form of inflammatory bowel disease or gastrointestinal malignancy (celiac disease is okay if you have been treated and no longer experience signs or symptoms), and/or anal fissures and fistulas
- Have a history of Zenker's diverticulum (pouches in the lower part of the throat), dysphagia (trouble swallowing), esophageal stricture (abnormal tightening or narrowing in the throat), eosinophilic esophagitis (allergic condition in the throat) or achalasia (nerve damage in the throat that prevents swallowing)
- Are pregnant or lactating (breastfeeding)

Important Safety Information

Warnings:

⚠ The Vibrant Capsule is magnetic resonance (MR) unsafe. The device has not been evaluated for safety and compatibility in the MR environment. It has not been tested for heating, migration, or image artifact in the MR environment. Undergoing an MRI (magnetic resonance imaging) while the Capsule is inside your body may result in injury, including serious damage to your intestinal tract or abdominal cavity.

- If you require an MRI, instruct your physician to verify that no Capsules are currently in your body via abdominal X-ray before undergoing an MRI examination.

⚠ After ingesting a Vibrant Capsule and until it has left the body, you should not be near any source of powerful electromagnetic fields such as one created near an MRI device.

⚠ The Capsule should be kept away from implants such as pacemakers, defibrillators, nerve stimulators, and other devices that could be affected by proximity to a DC (direct current) magnetic field.

⚠ If you have reasonable doubt concerning the integrity of a Vibrant Capsule, it should not be used and should be discarded.

⚠ If after ingesting a Vibrant Capsule you will experience one of the following symptoms, contact a physician immediately and stop taking additional Capsules until instructed by your physician:

- Black, bloody or tarry stools;
- Abnormal abdominal pain, including new onset of abdominal pain, change in the character of a previously existing abdominal pain, or persistent abdominal pain;
- Nausea or vomiting; or
- Believe a Capsule has not been expelled from the body, after two weeks from the time of ingestion.

⚠ Under no circumstances should a Vibrant Capsule be swallowed without prior activation in the Pod.

⚠ Vibrant Capsules must be stored in a safe place, out of the reach of children and/or infants.

- If a child has accidentally swallowed an unused Vibrant Capsule, the child should be brought immediately to a hospital.

⚠ Use of Vibrant equipment adjacent to or stacked with other equipment should be avoided because it could result in improper operation. If such use is necessary, the components of the Vibrant System and the other non-Vibrant equipment should be checked to verify that they are operating normally.

⚠ Use of accessories, transducers and cables other than those specified or provided by the manufacturer of this equipment could result in increased electromagnetic emissions or decreased electromagnetic immunity of this equipment and result in improper operation.

⚠ Portable RF (radio frequency) communications equipment (including peripherals such as antenna cables and external antennas) should be used no closer than 30 cm (12 inches) to any part of the Vibrant Pod, including cables specified by the manufacturer. Otherwise, degradation of the performance of this equipment could result.

⚠ Users should inspect the Pod and Capsule blister pack for possible tampering. If you suspect someone tampered with the Pod, then the device should not be used. If you suspect someone tampered with the blister cell for a Capsule, then that Capsule should not be used. Signs of possible tampering include, but are not limited to:

- For the Pod - cracks or breaks in the Pod casing, scratches around the screw holes, and scratches/marks around the USB port that the user does not recognize.

- For the Capsule - damage to the blister cell, or the Capsule is not in a sealed blister cell.

⚠ Patients with pelvic floor dyssynergia (condition where the muscles in the pelvic floor no longer work in unison) may have impaired muscular ability to evacuate stool; therefore, they should be monitored for any signs of adverse response and to ensure ability to pass the Capsule.

⚠ The Vibrant System has not been assessed in patients with chronic use of non-steroidal anti-inflammatory drugs (NSAIDs). Chronic use means taking full dose NSAIDs more than three times a week for at least six months.

Precautions

- Do not use the Pod or Capsules if packaging is damaged.
- Read this patient label and the instructions for use in its entirety before using the Vibrant System.
- A Vibrant Capsule should not be taken after its expiration date.
- Avoid biting the Vibrant Capsule prior to swallowing.
- Long-Term Use: The safety and effectiveness of the Vibrant System for long-term use has not been evaluated. Long-term use means more than 8 weeks. Therefore, a physician who decides to prescribe the Vibrant System to a patient for longer than 8 weeks should re-evaluate the individual patient including for long-term usefulness of the device.

What are the Expected Benefits and Risks of Using the Vibrant System?

The Vibrant System is expected to improve symptoms of chronic idiopathic constipation (see description above). The primary expected benefit is an increase in bowel movements that are associated with a feeling of complete evacuation, without the need for medication. The pivotal clinical study of the Vibrant System showed that nearly twice as many patients had at least 1 more of this type of bowel movement per week while using the Vibrant System compared to patients who used a placebo (inactive biodegradable softgel Capsule) treatment (40% versus 22%). The study also found that more patients reported improvement in quality of life after using the Vibrant System compared to patients who used the placebo treatment (77.9% versus 66.2%). Patients who used the Vibrant System reported less straining during bowel movements and improved stool consistency (less lumpy or hard) than patients who used the placebo treatment.

Based on clinical testing, potential side effects associated with the use of this device may include abdominal pain, abdominal distension (swollen abdomen), abdominal discomfort, vomiting, nausea, blood in stool, diarrhea, flatulence (passing gas) and proctalgia (pain due to a spasm of the pelvic floor muscles). In rare cases, obstruction may occur.

Note the safety and effectiveness of the Vibrant System for long-term use has not been evaluated. Long-term use means more than 8 weeks.

How to Use the Vibrant System

Setting Up the Pod

1. Connect the USB cable to the AC/DC adaptor and to the Pod.

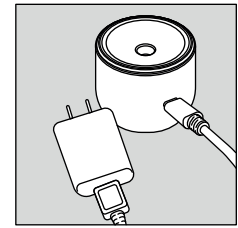
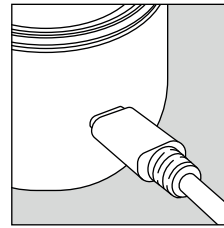
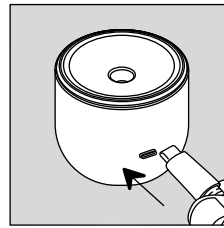
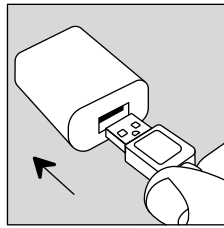

2. Connect the AC/DC adapter of the Pod to an electrical outlet. A short 'beep' will be heard, and the light ring indicator will flash for about 40 seconds before turning solid blue, indicating that the Pod is ready for use.

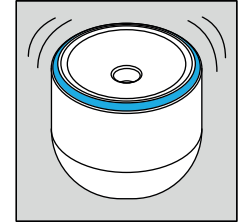
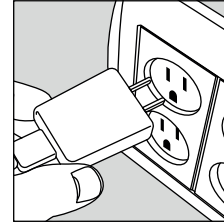

3. When using the Pod, it is recommended to keep it powered on for approximately 10 minutes.

Activating and Taking the Capsule

The Capsule must be activated before it is swallowed.
To activate a Capsule:

1. Remove one Capsule from the blister package.

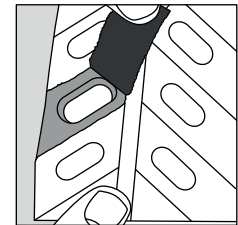
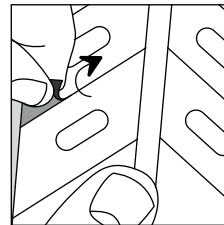

2. Remove the Pod cover.

3. Verify the light ring indicator is solid blue.

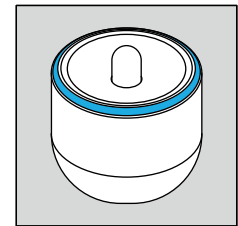
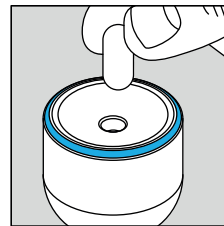

4. Check to ensure the absence of foreign matter in the Capsule groove prior to use. Place Capsule in the designated groove in the center of the Pod. Remove your hand and wait.

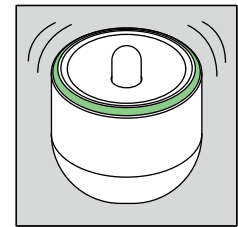
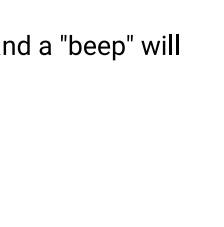

5. The light ring indicator will flash for a few seconds before turning solid green, and a "beep" will be heard, indicating the capsule is activated.

 Now the Capsule is ready to be swallowed.

7. Immediately swallow the Capsule with one glass (~8 ounce) of water. After removing the Capsule from the Pod, the light ring indicator turns blue.

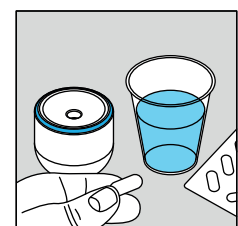

8. Replace the Pod cover.

9. Keep the Pod powered on for approximately 10 minutes before disconnecting it.

10. The Capsules are intended to be orally ingested up to 5 times per week, as directed by a physician. The Capsule should be taken shortly before going to sleep on 5 out of 7 days of the week according to the following schedule:
3 days on, 1 day off, 2 days on, 1 day off.

Caution: Do not connect the USB cable to any other device (such as a computer) as this may potentially harm the Pod.

Storage and Maintenance Instructions

Pod

- Keep the Pod in a dry place away from direct sunlight (not in the kitchen or in the bathroom).
- Thoroughly clean the Pod prior to first use and after each use. The Pod should be cleaned using a clean cloth and 70% isopropyl alcohol, and the lid should be closed after cleaning and between uses.
- In the case of electromagnetic disturbance, reset the Pod by unplugging the AC/DC adaptor from the wall power outlet and plugging it back in after a few seconds.

Capsules

- The Vibrant Capsules should be stored in a dry, cool place (below 25°C/77°F), away from magnetic sources and away from direct sunlight (not in the kitchen or in the bathroom).
- Keep the Vibrant Capsules in the sealed blister pack until use.
- Even if stored in their original containers and according to recommendations, the Vibrant Capsules can be kept for a limited period only. Please note the expiration date of the Capsules.

Symbols

 **ONLY** | Federal (U.S.) law restricts this device to sale by or on the order of a physician.

 | The Capsule component is intended for single use

 | Keep dry

 | Protected from touch by fingers and objects greater than 12 mm

 | Type BF applied part

 | For additional information on how to use the Vibrant System, please call: 866- 359-7532 (toll free)

 | For additional information regarding the Vibrant System, you may visit our website at www.vibrantgastro.com

US Office Address: 9600 Great Hills Trail, Suite 150W, Austin, Texas, 78759

Manufactured by Vibrant LTD, Hakochav Building, 2 Hacarmel St., Yokneam 2069206, Israel